

# Übersicht über Stutzenplatzierung auf VEX100 - VEX200 - VEX300

1.1. Abluft 1.2 Fortluft 2.1. Aussenluft 2.2 Zuluft

VEX100 - Horizontal/Ceiling LINKS

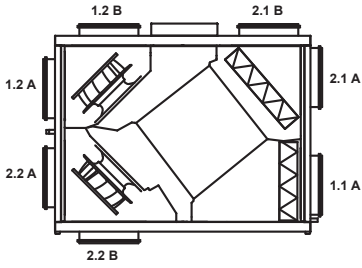

VEX100 - Horizontal/Ceiling RECHTS

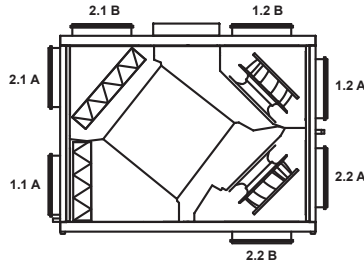

VEX100 - Vertikal LINKS

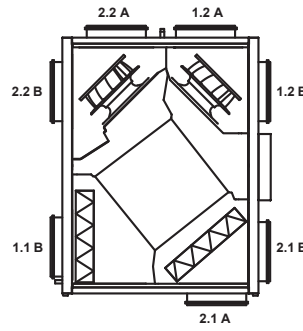

VEX100 - Vertikal RECHTS

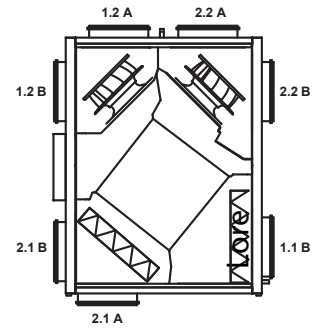

VEX200 - Kompaktfilter  
Ventilatoranordnung 1 - LINKS

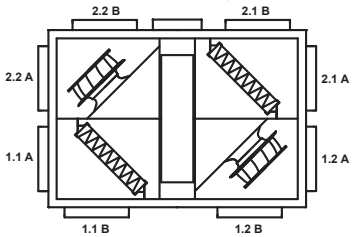

VEX200 - Taschenfilter  
Ventilatoranordnung 1 - LINKS

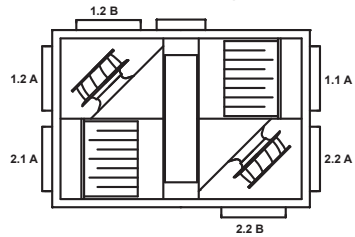

VEX200 - Kompaktfilter  
Ventilatoranordnung 1 - RECHTS

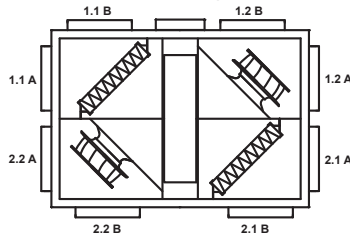

VEX200 - Taschenfilter  
Ventilatoranordnung 1 - RECHTS

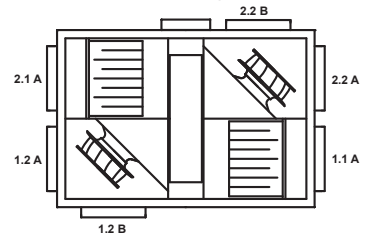

VEX320/330 LINKS \*  
(Deckengerät)

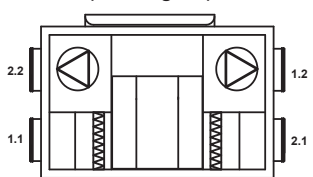

VEX320/330 RECHTS \*  
(Deckengerät)

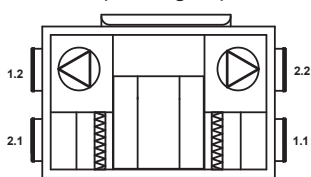

VEX330 Horizontal \*\*

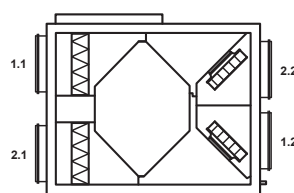

\* Blick von unten auf die Revisionstür!

\*\* VEX330H kann von vorne oder von hinten revisioniert werden - somit als Links- oder Rechtsgerät verwendbar!

VEX340 LINKS

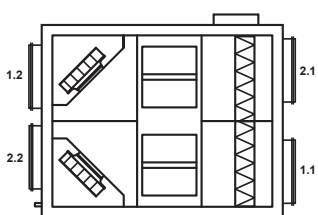

VEX340 RECHTS

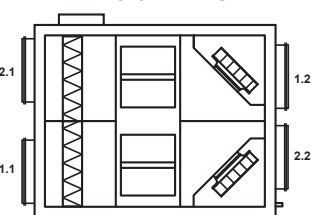

VEX350/360 LINKS

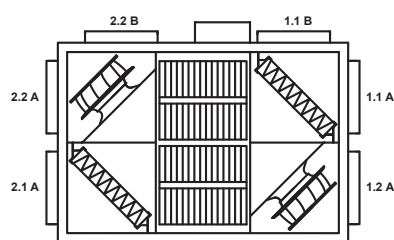

VEX350/360 RECHTS

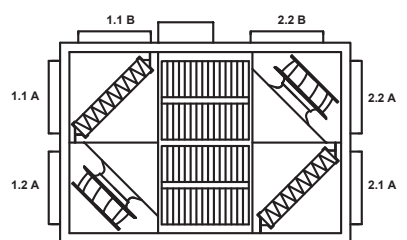

# Übersicht über Stutzenplatzierung auf VEX100 - VEX200 - VEX300

1.1. Abluft 1.2 Fortluft 2.1. Aussenluft 2.2 Zuluft

VEX370 LINKS

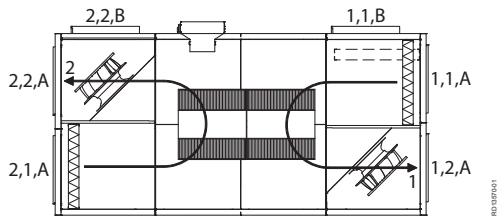

VEX370 RECHTS

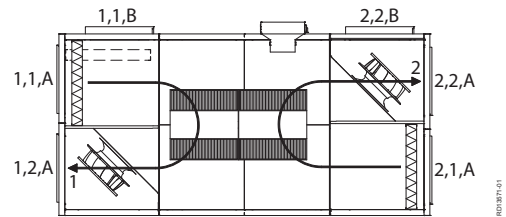

VEX370 Flue Gas LINKS

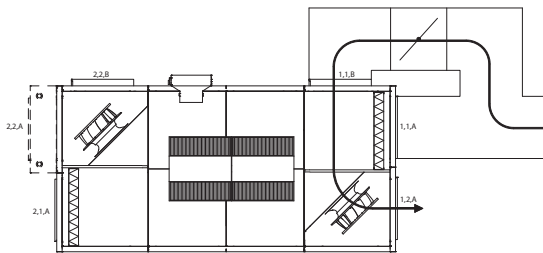

VEX370 Flue Gas RECHTS

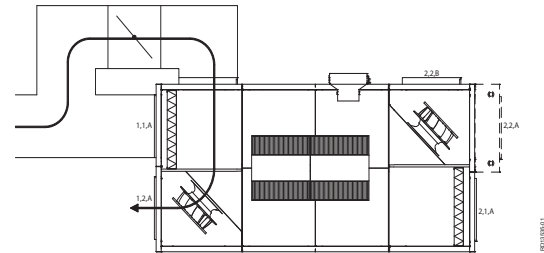

VEX370 HCWI LINKS

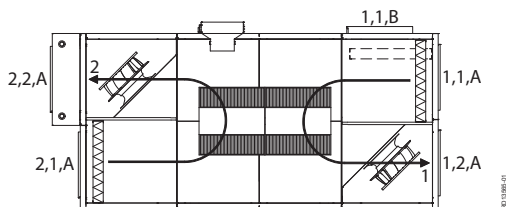

VEX370 HCWI RECHTS

